

LEGO

BRICK
HERAOS

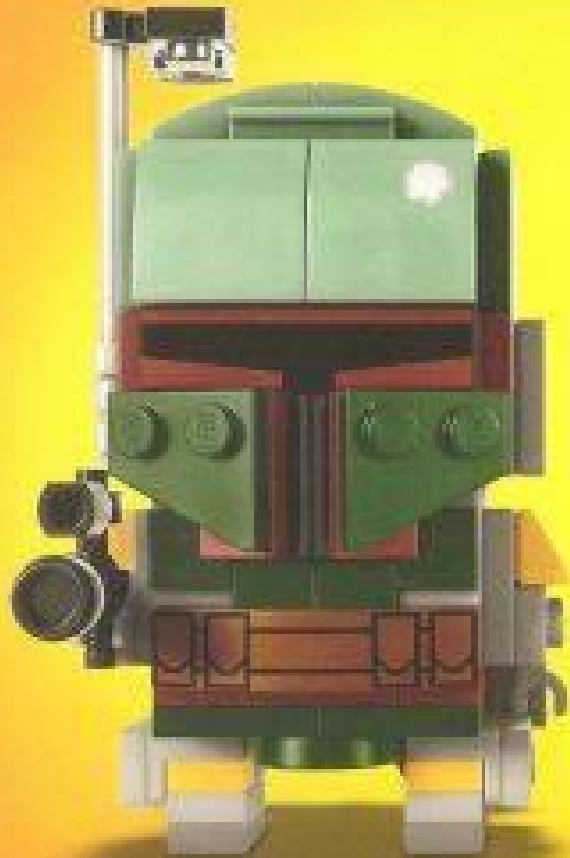

STAR
WARS

BOBA FETT™

MAY 2017
27

LEGO

41496

BRICK
HERAOS



STAR
WARS

HAN SOLO™ IN CARBONITE

MAY 2017
28

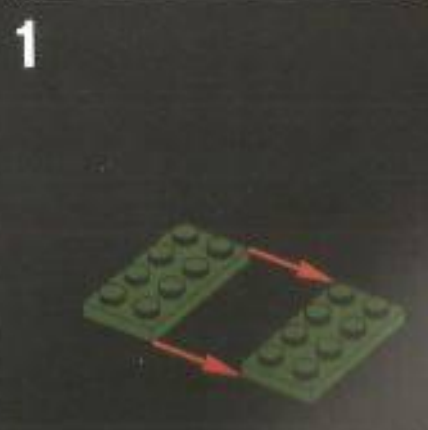

2



3



2



3



3



4



4



5



3



4



4

1



2



3



5



5



6



6

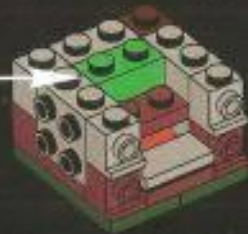

7



5



6

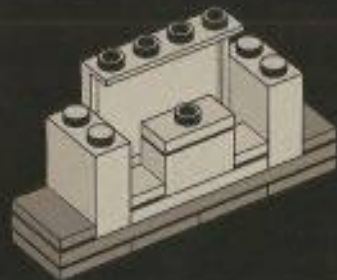

7



7



8



8

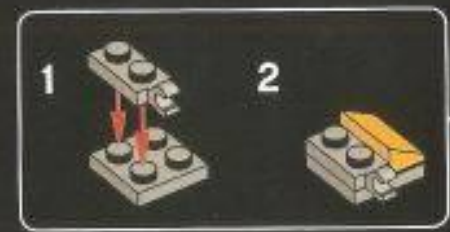

9



6

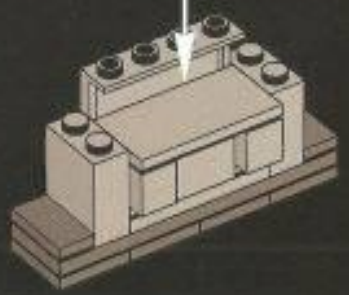

8



7

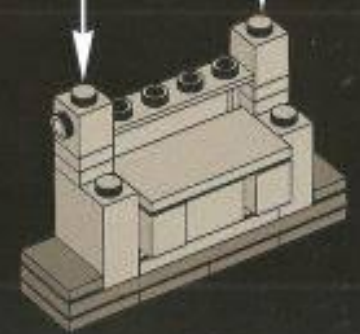
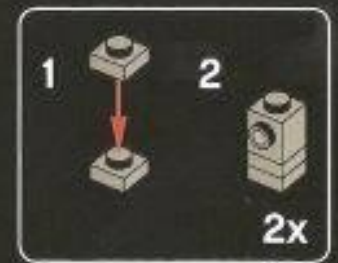

9



9

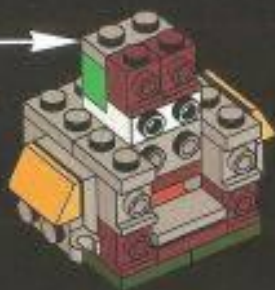
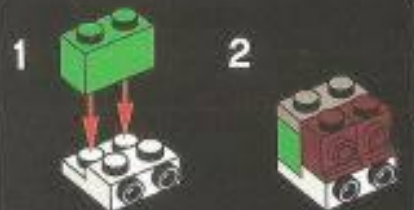

10



10

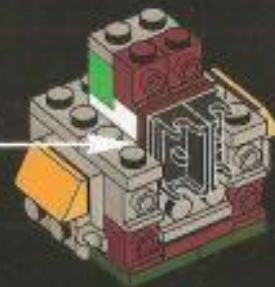

11



8

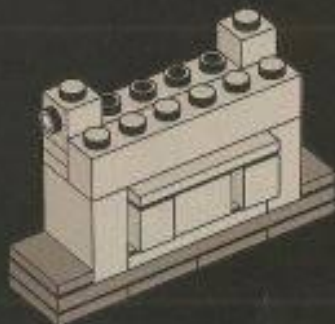

10



9

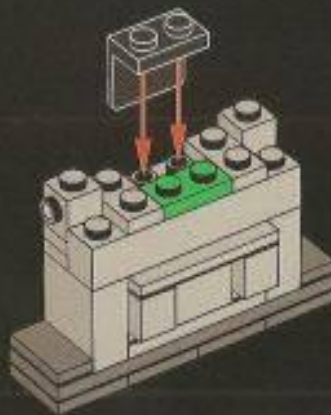

10

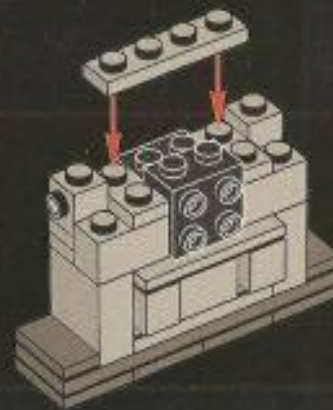

11

4x

11

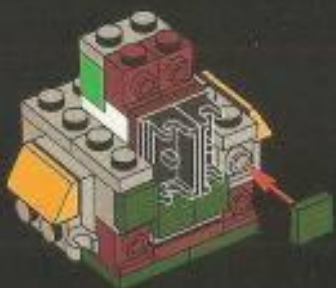

12

1x

12



1x

5x

13



13

2x

11

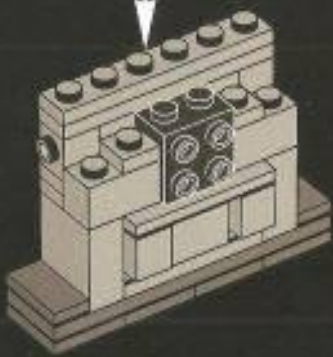
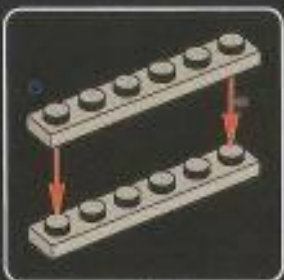

12

1x

1x

12

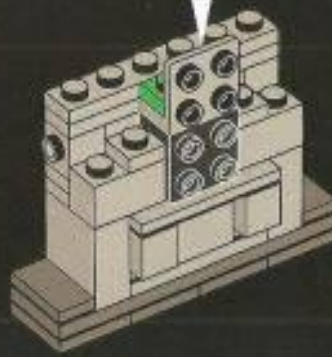

13



14

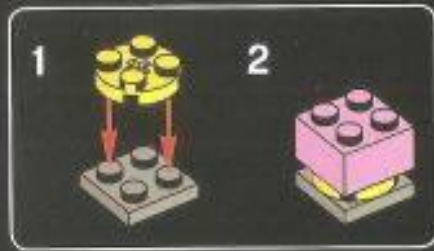

14



15

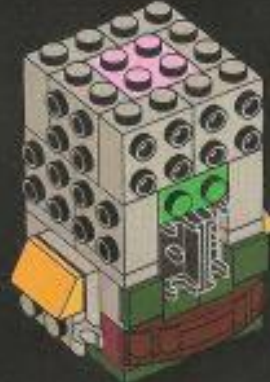

15



13

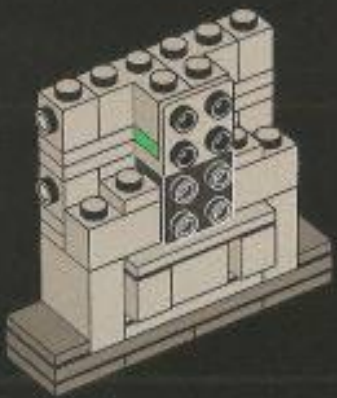

14



14

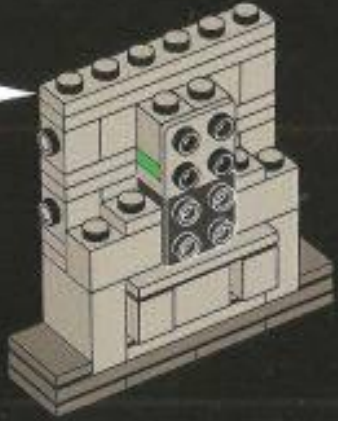
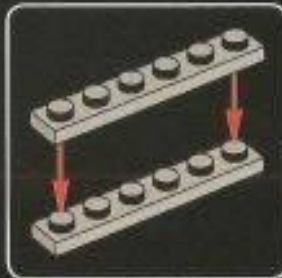

15



16

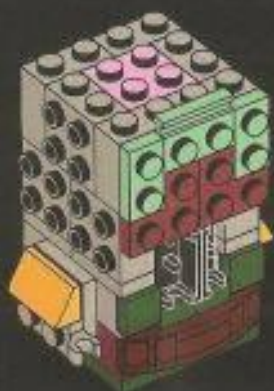

16



17

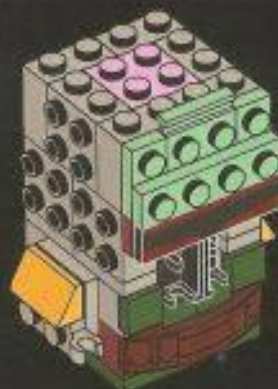

17



18



15

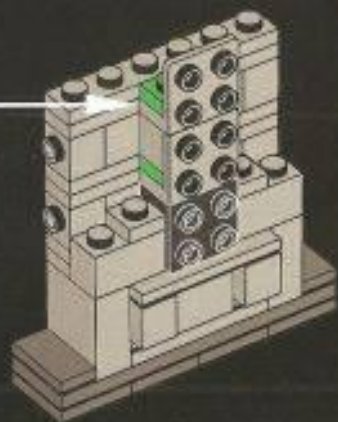

16



16

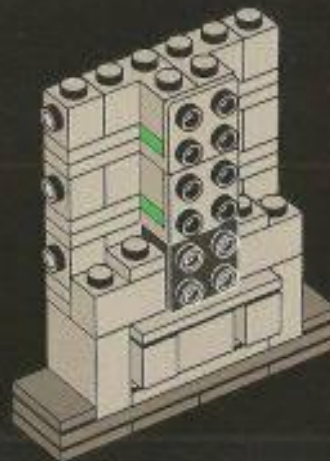

17



19

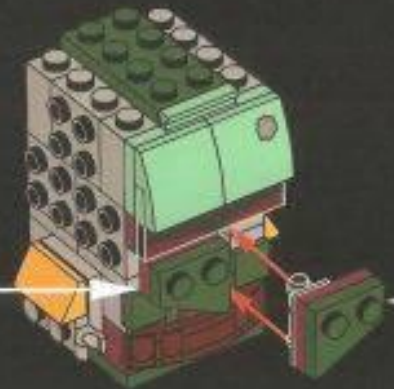

18



20



21



19



17



18



18

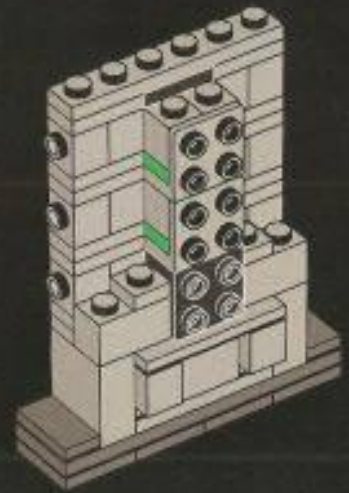

19



22



20



23



24



21



19

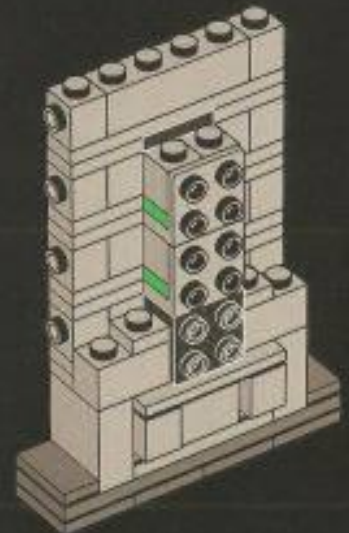

20



20

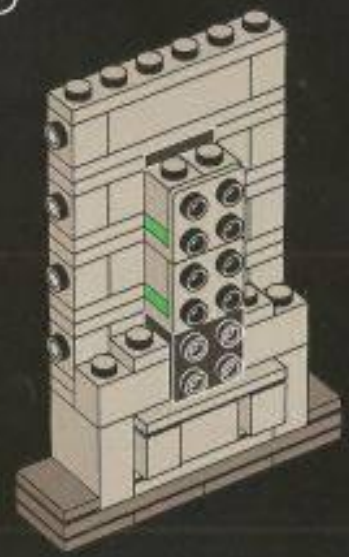

21



25

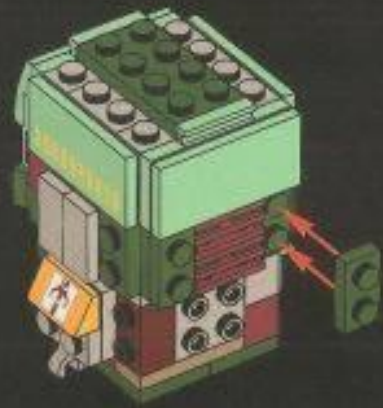

22



26



23



21

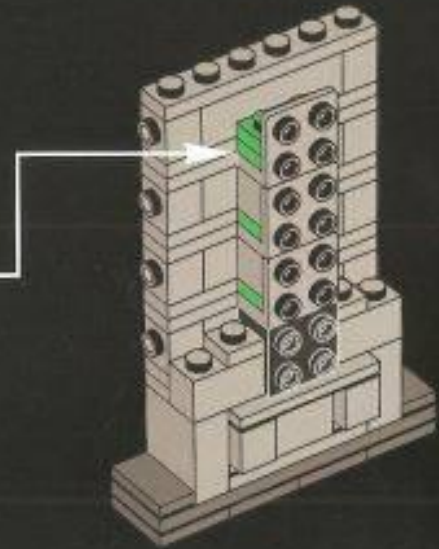
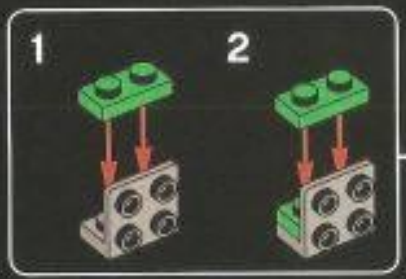

22



22

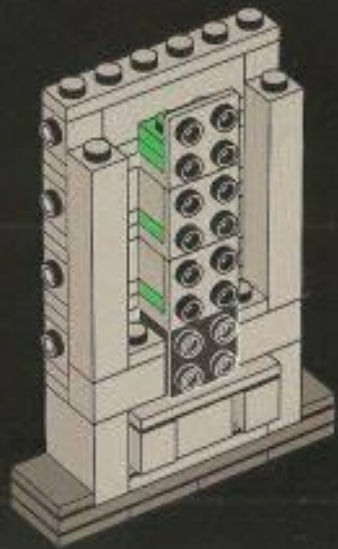

23



27



24



28

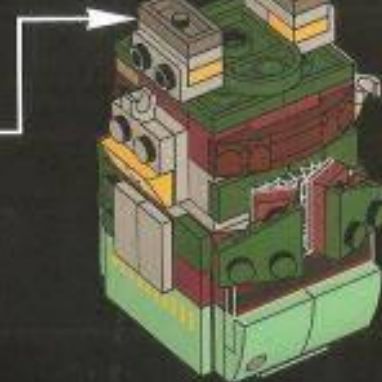

25



23

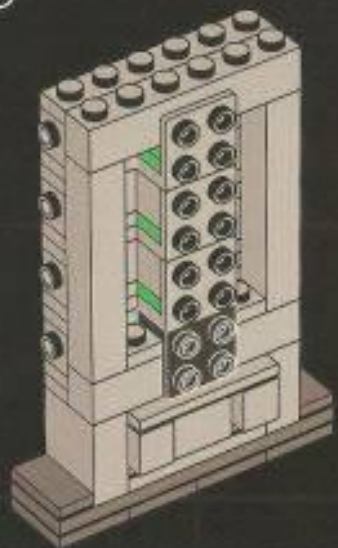

24



24

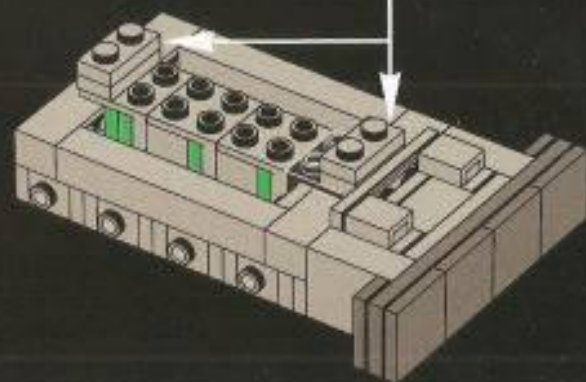

25



29



26



30



27



25

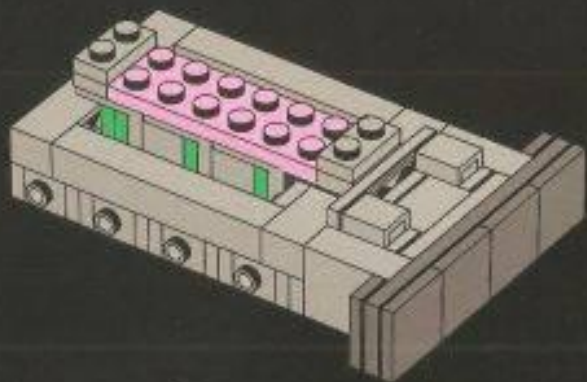

26



26

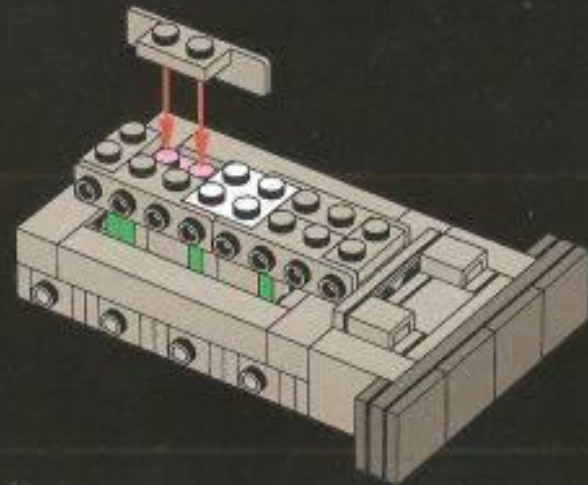

27



31



28



32

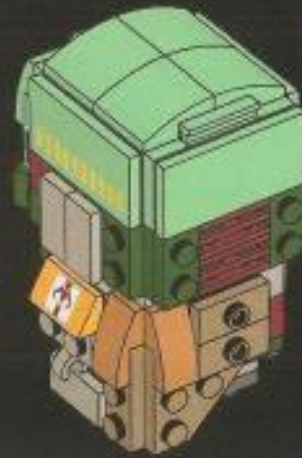

29



33



27

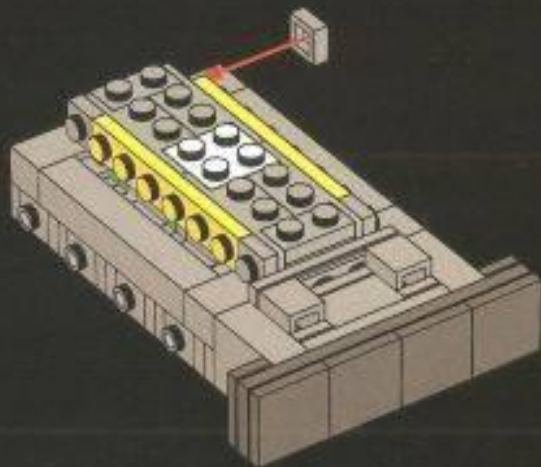

28



28

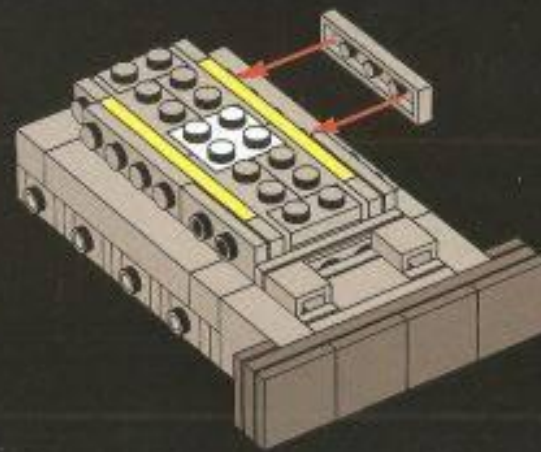

29



34



30



35



36

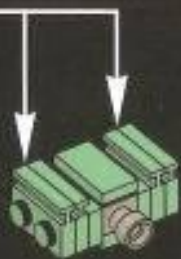
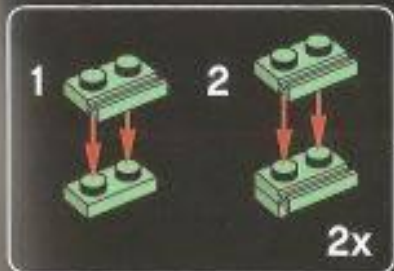

31



29

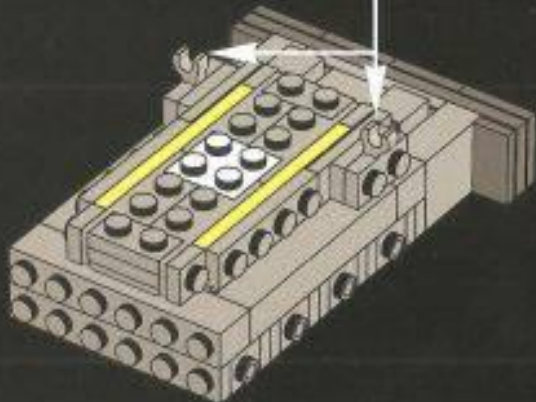

30



30

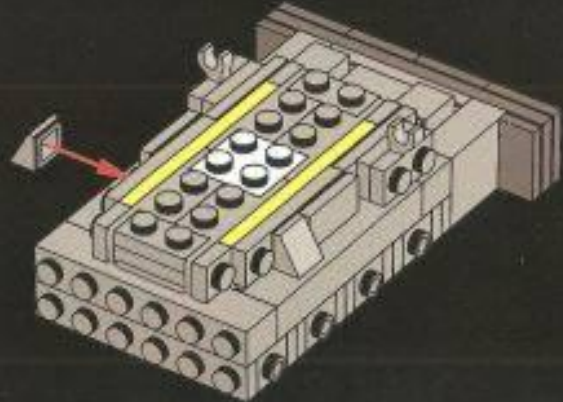

31



37

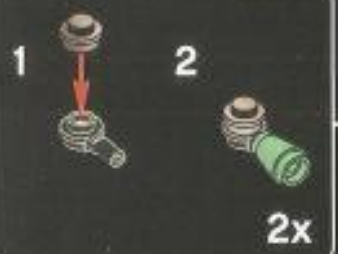

32



31

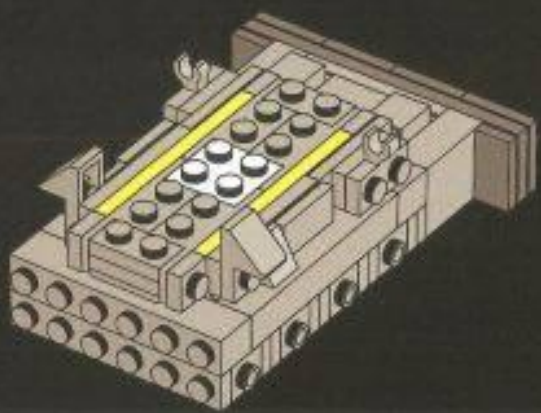

32



38

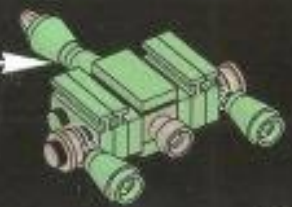

33



32

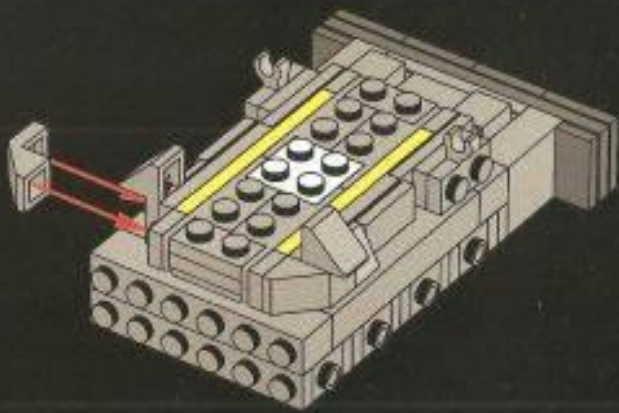

33

39



34



40

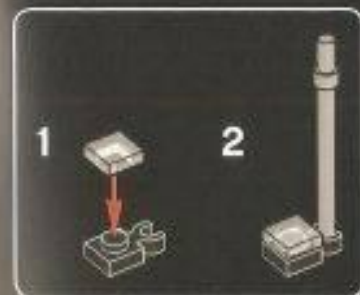

35

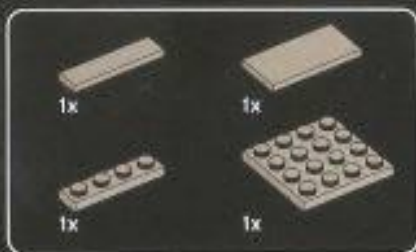

33

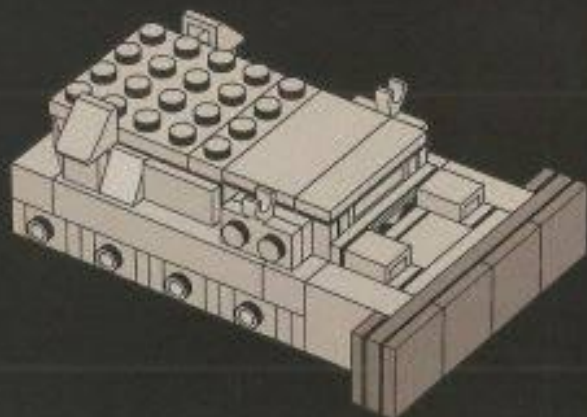

34

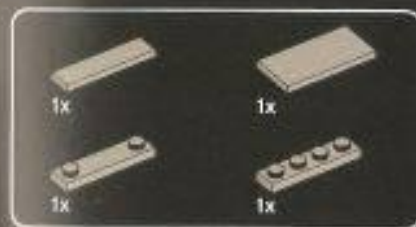

34

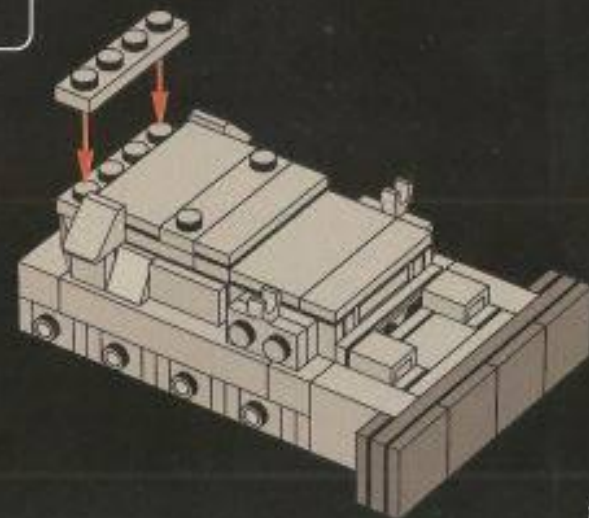

35



41

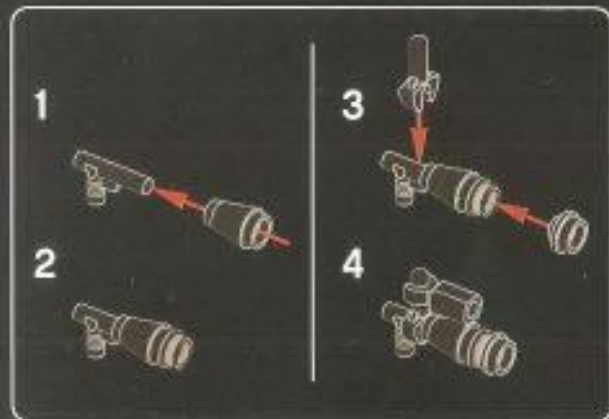

36

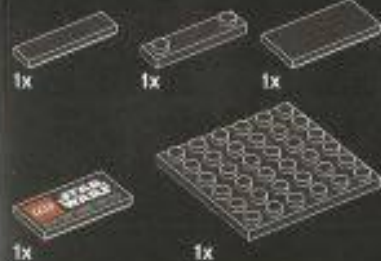

42



37



35

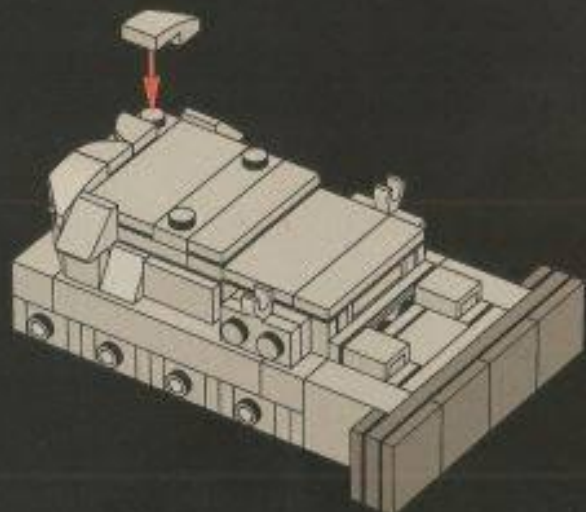

36



36

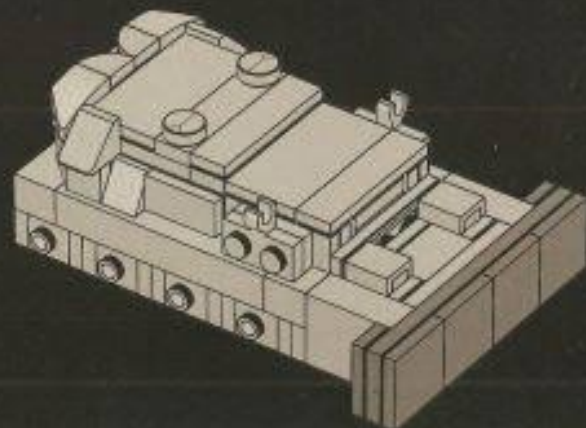

37



37

1

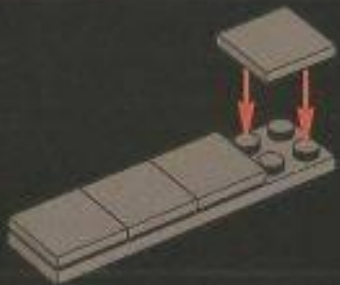

2

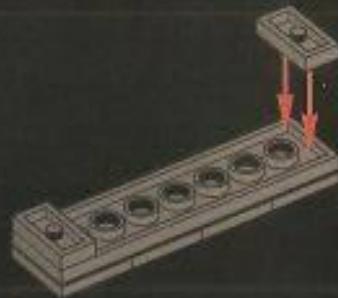

38

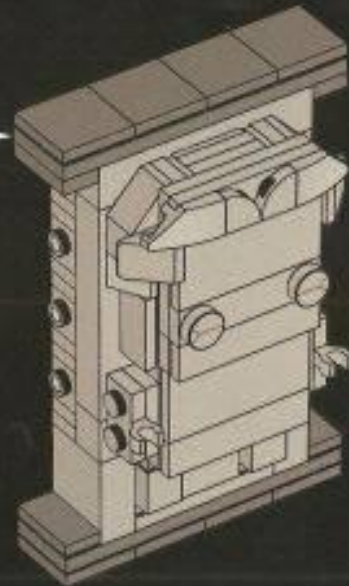

39



2x

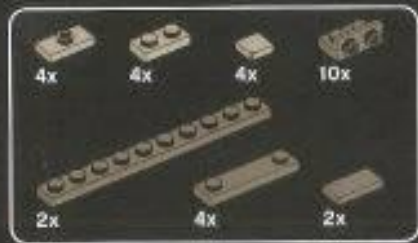

38

1

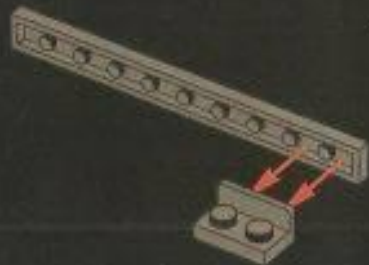

40

2

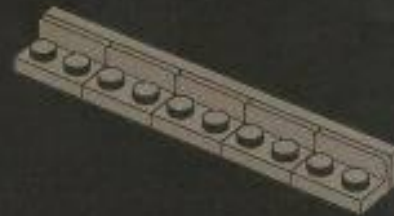

3

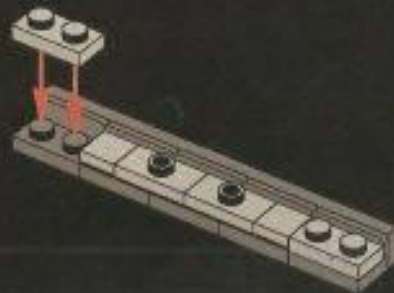

41

4



2x

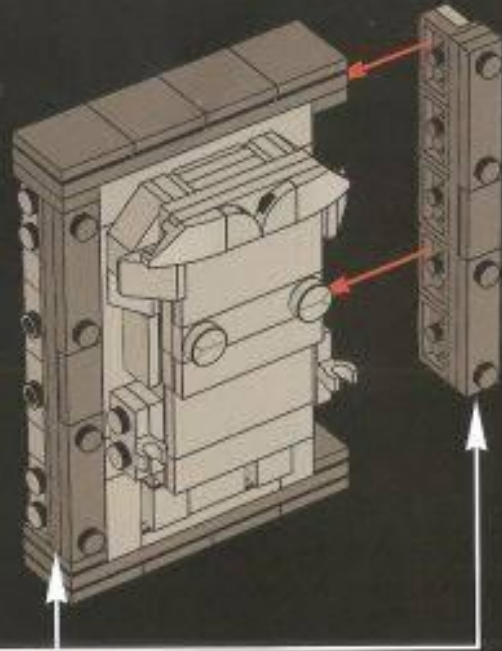

42

39

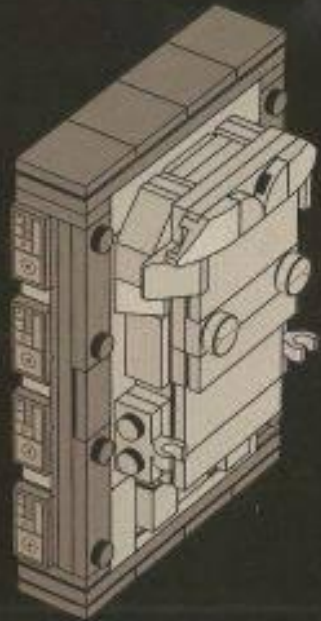

43



40

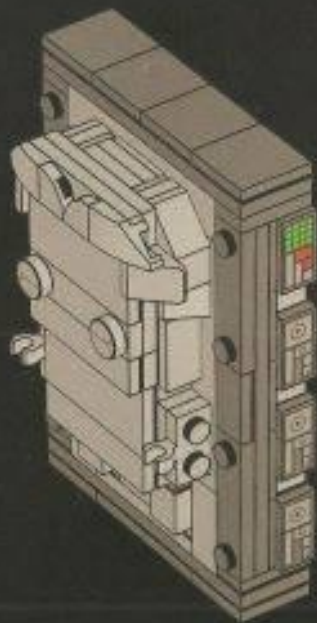

44



41



45

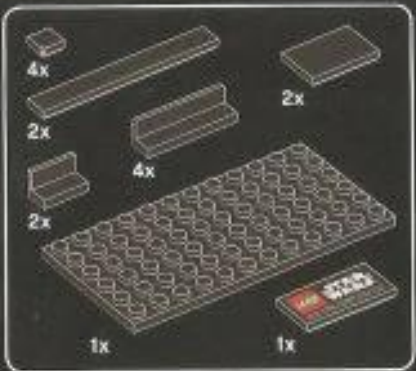

42

1

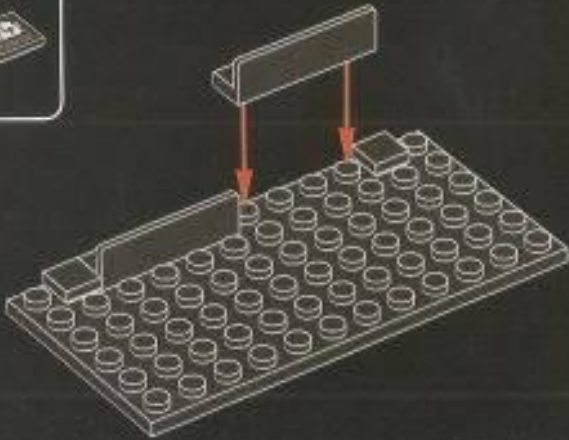

2

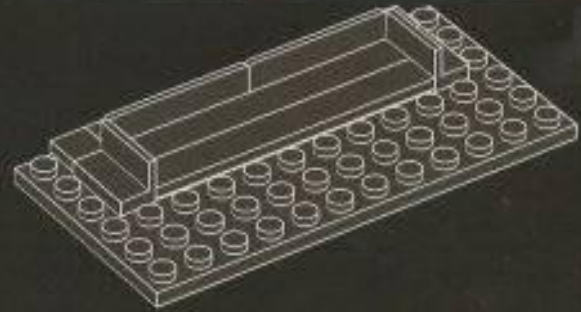

3





48

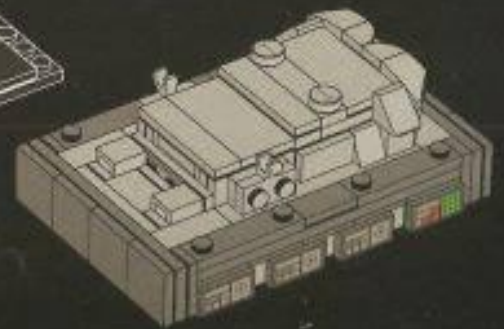

49



1x
6046979



1x
614321



1x
403224



1x
601569



1x
614126



1x
4529236



1x
4289535



1x
4559017

38



2x
6196548



1x
4537561



2x
393826



2x
393726



1x
6224531



1x
243126



1x
4592499



1x
4660182



1x
6224859



1x
396126



3x
4107736



1x
6047501



1x
6053172



2x
6092591



2x
6132768



1x
6038637



6x
6055171

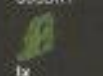

1x
6222411



1x
6222414

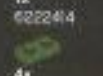

4x
6013109

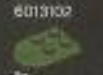

1x
6064112

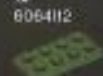

4x
4598057



2x
6134280



1x
4616578



7x
4655080



8x
6222362



5x
8050437



1x
6224528



1x
6100234



1x
6224839



2x
4633693



4x
4539092



1x
4541376



2x
4550869



2x
4541506



4x
4539097



4x
4565751



2x
6073040



1x
6024288



1x
6224539



1x
6201911



1x
4211189



1x
6224538



2x
4211399



2x
4211476



1x
4211389



6x
4211464



1x
6028812



1x
6015344



2x
4598526



14x
6123809



2x
4654582



1x
4535738



1x
4211502



6x
4211398



4x
4211597



1x
4211399



1x
4550359



4x
4211063



1x
6081975



1x
6162578



3x
4633693



1x
6122987



2x
6187648

Customer Service

Kundenservice

Service Consommateurs

Servicio Al Consumidor

LEGO.com/service or dial





Customer Service
 Kundenservice
 Service Consommateurs
 Servicio Al Consumidor
 LEGO.com/service or dial

: 00800 5346 5555																
: 1-800-422-5346																



**BRICK
'H'HEADZ**

**STAR
WARS**

LEGO, the LEGO logo and Brickheads are trademarks and/or copyrights of the LEGO Group.
©2007 The LEGO Group

Comic-Con and the Comic-Con logo are registered trademarks of New York Comic Convention.
starwars.com © & ™ Lucasfilm Ltd.



**BRICK
'H'HEADZ**

**STAR
WARS**

LEGO, the LEGO logo and Brickheads are trademarks and/or copyrights of the LEGO Group.
©2007 The LEGO Group

Comic-Con and the Comic-Con logo are registered trademarks of New York Comic Convention.
starwars.com © & ™ Lucasfilm Ltd.